

SANI MODULE SYSTEM

MANUEL TECHNIQUE

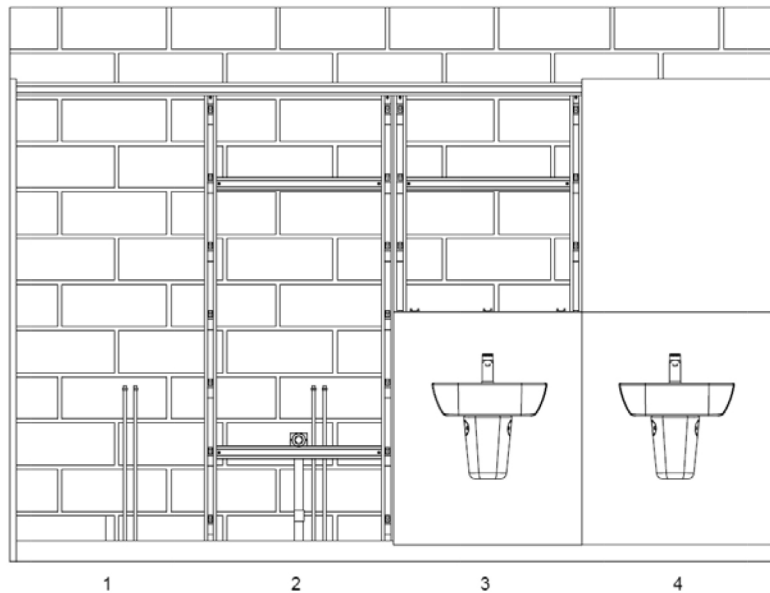

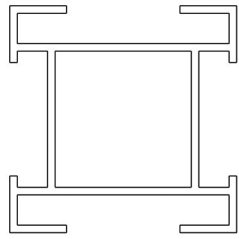

30156



03007

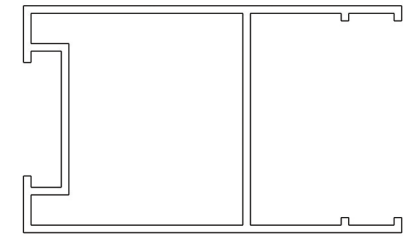

30157

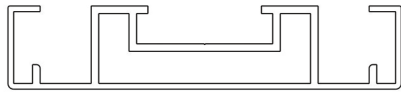

30163



30169

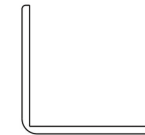

30162

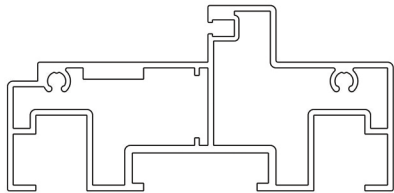

30161

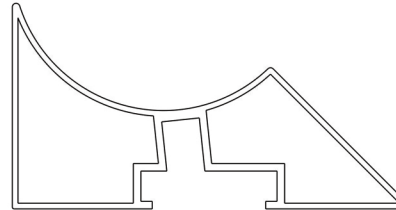

30167

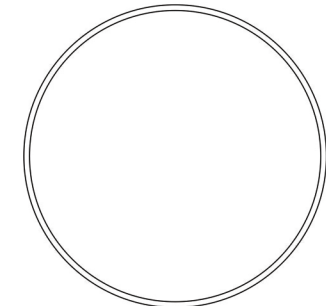

30168

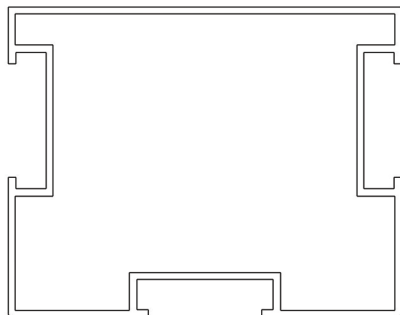

30166

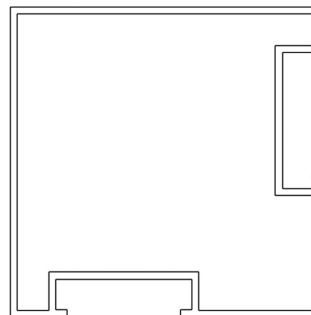

30165



30187

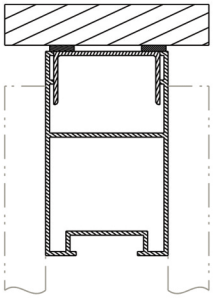

RAIL HAUT SUR PLAFOND

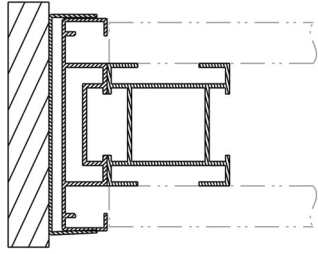

DEPART CLOISON SUR MUR

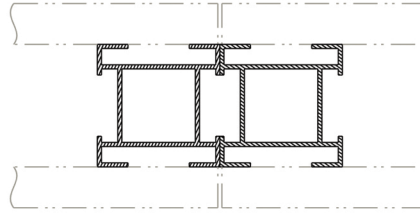

JONCTION EN LIGNE

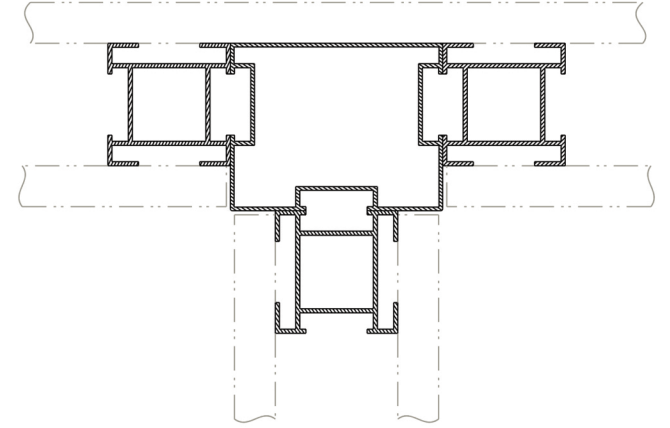

POTEAU 3 DEPARTS

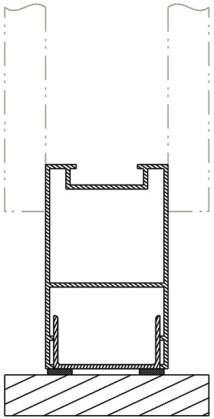

RAIL BAS

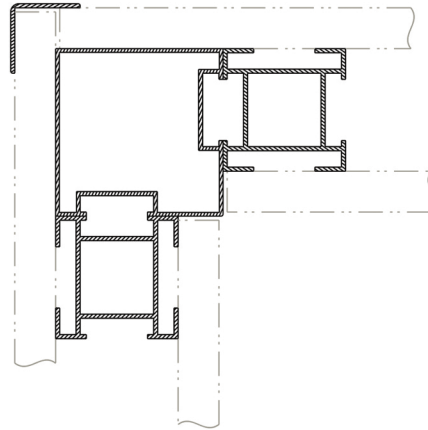

POTEAU ANGLE DROIT

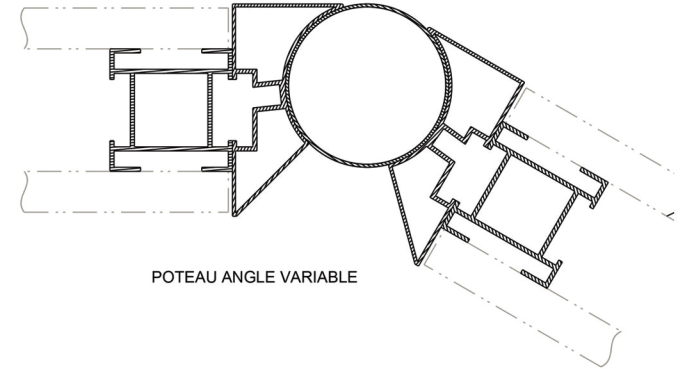

POTEAU ANGLE VARIABLE

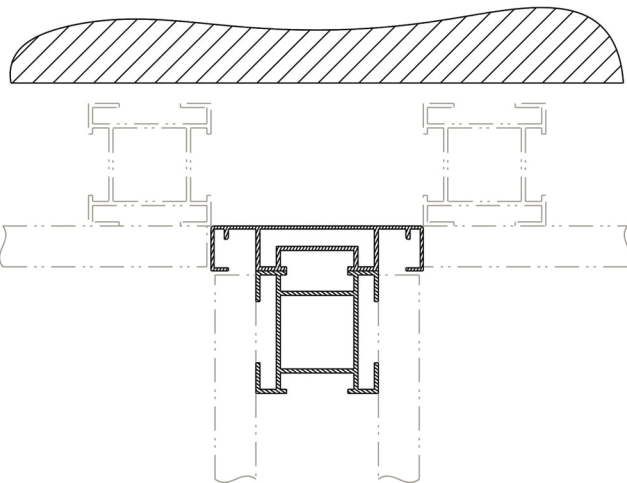

DEPART CLOISON SUR DOUBLAGE MUR

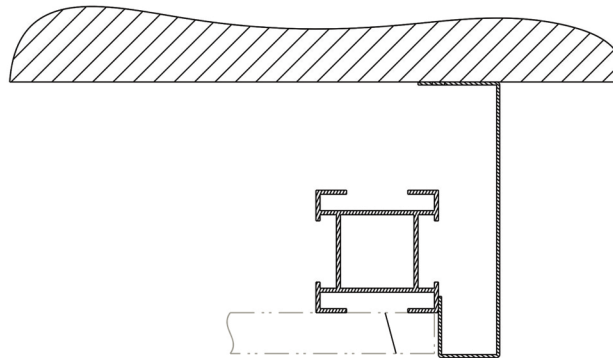

EXTREMITÉ DOUBLAGE

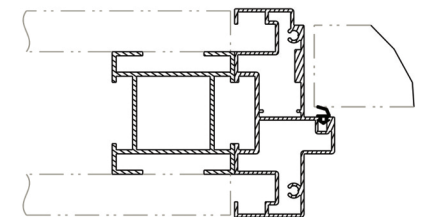

HUISSERIE

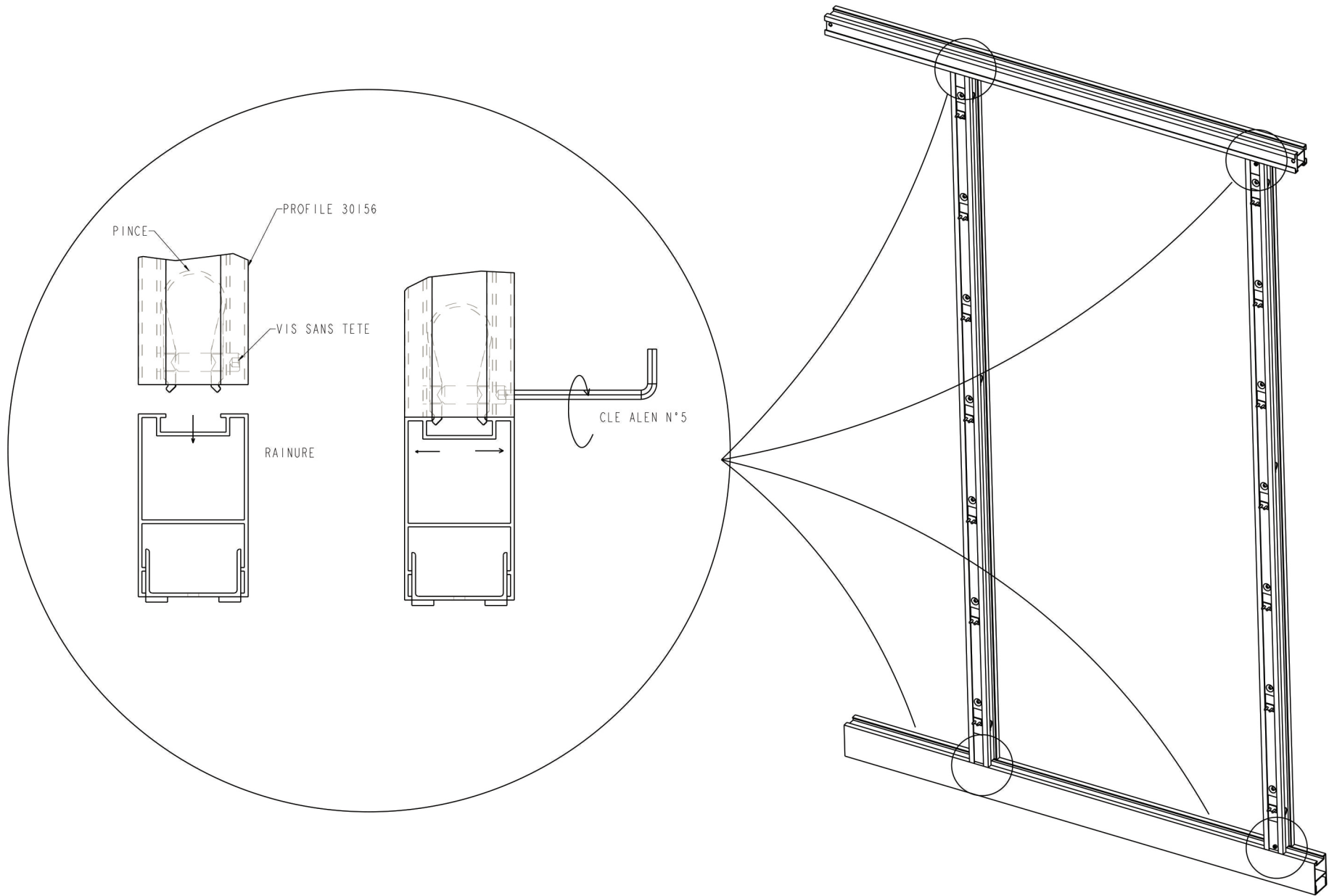

ASSEMBLAGE POTEaux SUR RAILS

INSERT DANS RAINURE PROFIL

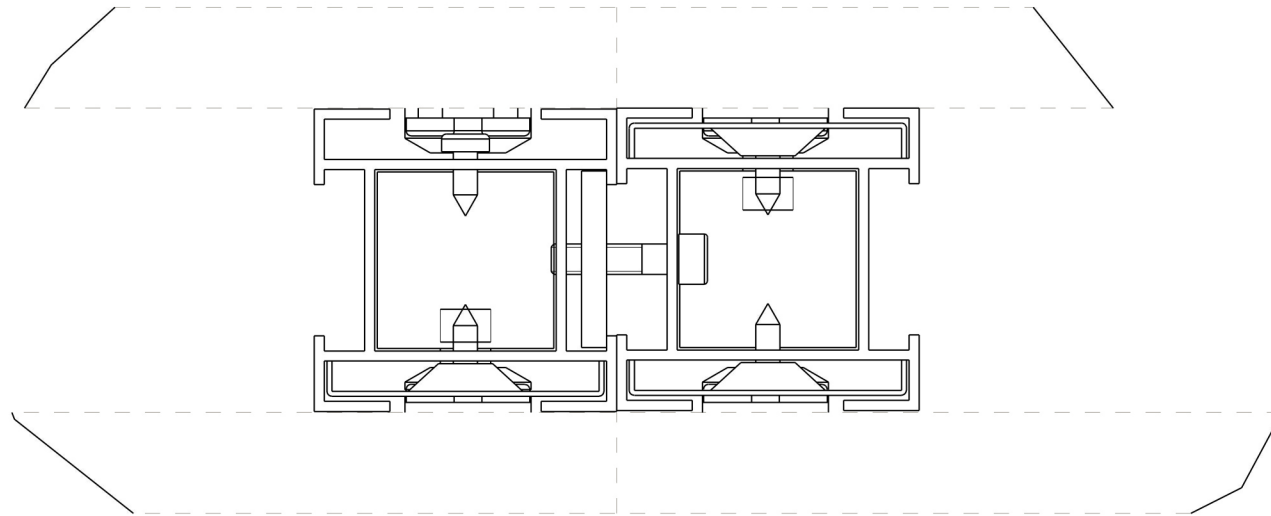
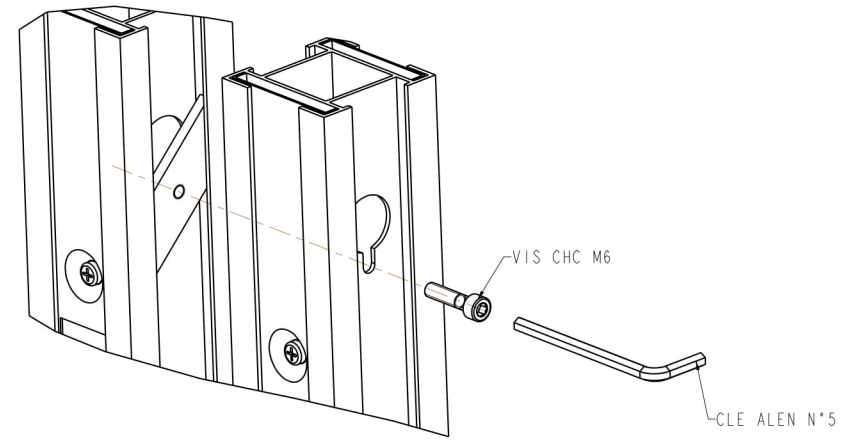

ASSEMBLAGE ENTRE POTEAUX